

SMART PRESSURE TRANSMITTER APC-2000ALW

- ✓ 4...20 mA output signal + HART protocol
(special version: 0...20 mA or 0...5 mA output signal + HART protocol)
- ✓ Display with backlight
- ✓ Programmable range, zero shift, characteristic and damping ratio with local panel keys
- ✓ SIL 2 certificate
- ✓ Intrinsic safety certificate (ATEX, IECEx)
- ✓ Explosion proof certificate (ATEX, IECEx)
- ✓ Marine certificate – DNV, BV
- ✓ PED Conformity (97/23/EC)
- ✓ Accuracy 0.075% (0.05%, 0.04% on request)
- ✓ Gold plated diaphragm (Au)
- ✓ MID (Measuring Instruments Directive) – certificate acc. to 2004/22/WE directive and OIML R140:2007 recommendations.

up to 5 years warranty

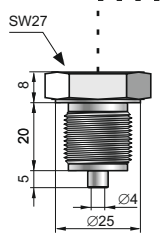
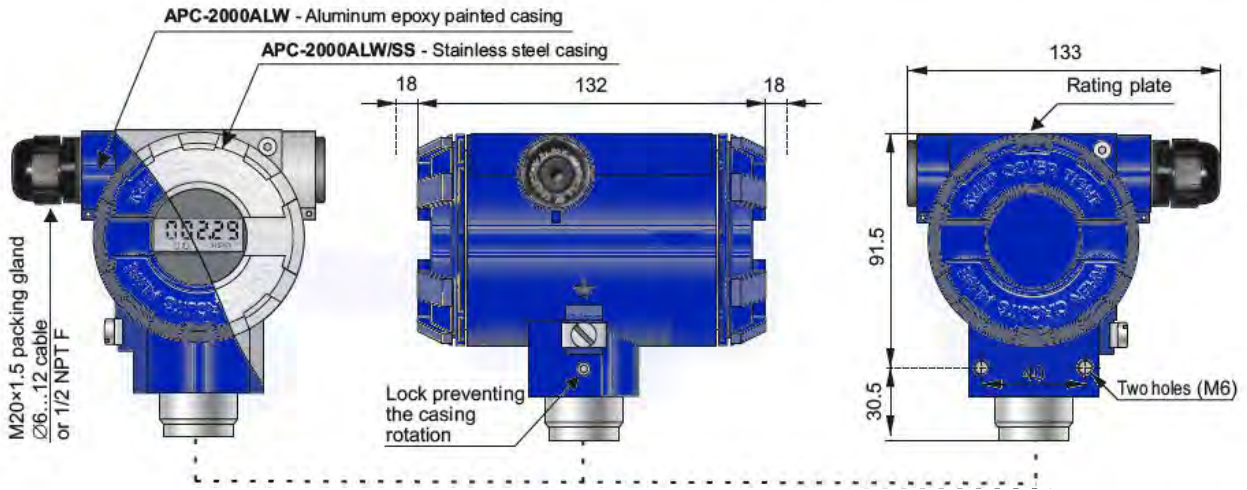

**G1/2 type
M type**
G1/2", Ø4 hole
M20x1.5, Ø4 hole

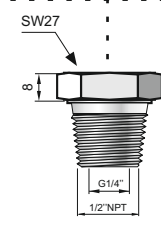

1/2" NPT M type
1/2" NPT male +
internal thread G1/4"

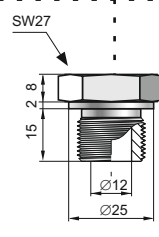

**GP type
P type**
G1/2", Ø12 hole
M20x1.5, Ø12 hole

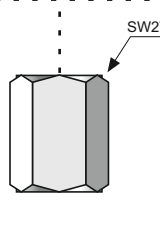

1/2" NPT F type
internal thread
1/2-14NPT

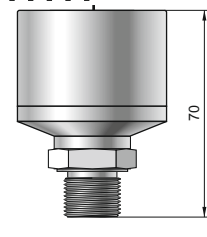

**GP type
P type**
1/2" NPT M type
for HS version

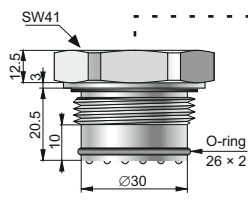

CG1 type
G1" with flush diaphragm

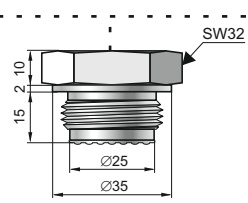

CM30x2 type
M30x2 with flush diaphragm

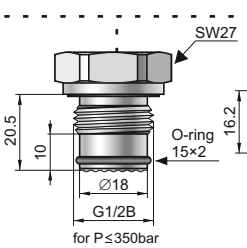

CG1/2 type
G1/2" with flush diaphragm
for P ≤ 350bar

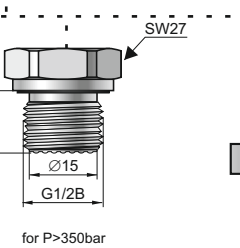

CG1/2 type
G1/2" with flush diaphragm
for P > 350bar

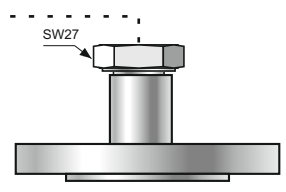

**Version with direct or remote
diaphragm seal**
Diaphragm seal data -
see chapter III

Application and construction

Smart pressure transmitters are applicable to the measurement of the pressure, underpressure and absolute pressure of gases, vapours and liquids. The active sensing element is a piezoresistant silicon sensor separated from the medium by a diaphragm and by specially selected type of manometric liquid. The casing is made of aluminium alloy cast or 316SS stainless steel, degree of protection IP66/IP67. The design of the casing enables the use of a local display, rotation of the display, rotation of the casing by 0–340° relative to the sensor, and a choice of cable direction.

The communication standard for data interchange with the transmitter is the Hart protocol.

Communication with the transmitter is carried out with:

- a KAP-03, KAP-03Ex communicator
- some other Hart type communicators, (*)
- a PC using an HART/USB converter and Report 2 configuration software.

The data interchange with the transmitter enables users to:

- ◆ identify the transmitter
- ◆ configure the output parameters:
 - measurement units and the values of the start points and end points at the measurement range
 - damping time constant
 - conversion characteristic (inversion, user's non-linear characteristic)
- ◆ read the currently measured pressure value of the output current and the percentage output control level
- ◆ force an output current with a set value
- ◆ calibrate the transmitter in relation to a model pressure

Installation

The transmitter can be installed directly on the installation. An universal mounting bracket is provided to transmitter fitting on 2" pipe (the AL mounting bracket, see page IV/5). When the pressure of steam or other hot media is measured, a siphon or impulse line should be used. The needle valve placed upstream the transmitter simplifies installation process and enables the zero point adjustment or the transmitter replacement. When the special process connections are required for the measurement of levels and pressures (e.g. at food and chemical industries), the transmitter is provided with a diaphragm seal. Installing accessories and a full scope of diaphragm seals are described in detail in the further part of the catalogue. The transmitter's electrical connections should be performed with twisted cable. The place for the communicator should be assigned before the communicator installation.

Measuring ranges

No.	Nominal measuring range (FSO)	Minimum set range	Rangeability	Overpressure limit (without hysteresis)****
1	0...14,500 psi	145 psi	100:1	17,400 psi
2	0...8,700 psi	87 psi	100:1	17,400 psi
3	0...4,350 psi **	45 psi	100:1	6,500 psi
4	0...2,320 psi **	23 psi	100:1	6,500 psi
5	0...1,000 **	10 psi	100:1	2,000 psi
6	-15...1,000 psi **	10 psi	100:1	2,000 psi
7	0...360 psi **	3.6 psi	100:1	725 psi
8	-15...360 psi **	3.6 psi	100:1	725 psi
9	0...100 psi **	1 psi	100:1	200 psi
10	-15...100 **	1 psi	100:1	200 psi
11	-15...21.75 psi **	1.70 psi	20:1	60 psi
12	0...30 psi **	0.30 psi	20:1	60 psi
13	0...15 psi **	1.50 psi	20:1	30 psi
14	-7.25...7.25 psi **	0.75 psi	20:1	30 psi
15	0...3.5 **	0.35 psi	10:1	15 psi
16	-1.5...1.5 psi **	0.30 psi	10:1	15 psi
17	-0.25...1 psi */**	0.07 psi	17:1	7.25 psi
18	-0.35...0.35 psi */***	0.03 psi	25:1	7.25 psi
19	-0.1...0.1 psi */***	0.015 psi	14:1	7.25 psi
20	0...20 psia	1.50 psia	13:1	30 psi
21	0...100 psia	1.50 psia	70:1	200 psi
22	0...360 psia	3.6 psia	100:1	725 psi
23	0...1,000 psi	10 psia	100:1	2,000 psi
24	0...4,350 psi	45 psia	100:1	6,500 psi

* transmitters not available with diaphragm seal; not available in Exd version

** transmitters available in HS version

*** transmitters available only in HS version; not available with SIL2

**** overpressure limit can be different for version according to PED norm No. 97/23/EC

Technical data

Metrological parameters

Accuracy $\pm 0.075\%$ of the calibrated range
($\pm 0.1\%$ for range no. 19)

Special version: $\leq \pm 0.05\%$ of the calibrated range
($\pm 0.04\%$ on request)

Long-term stability \leq accuracy for 3 years
(for the nominal measuring range) or $\leq 2 \times$ accuracy for 5 years
HS version (ranges 3+15): \leq accuracy for 6 years
or $\leq 2 \times$ accuracy for 10 years

Thermal error $< \pm 0.05\%$ (FSO) / 50°F
(0.1% for ranges no. 16+19)
max. $\pm 0.25\%$ (FSO) in the whole compensation
range (0.4% for ranges no. 16+19)

Thermal compensation range -13...175°F
Special version: -40...175°F

Response time 16...480ms (programmable)
Exd version: 150ms

Additional electronic damping 0...60 s

Error due to supply voltage changes 0.002% (FSO) / V

Electrical parameters

Power supply: 10...55 VDC
Exia: 10,5...30 VDC / Exd: 10,5...45 VDC
SIL2: 15...45 VDC / SIL2 Exia: 16...28 VDC
MID Exia: 13,5...28VDC / MID Exd: 13,5...45 VDC

Output signal 4...20 mA + HART

Load resistance (for standard version) $R[\Omega] \leq \frac{U_{\text{sup}}[V] - 10V}{0,0225A}$

Resistance required for communication min. 240 Ω

Materials

Wetted parts and diaphragms: 316L SS, Hastelloy C 276, Au
Casing: Aluminum, 316SS
Material of window: polycarbonate glass, hardened glass

Operating conditions

Operating temperature range (ambient temp.) -40...175°F
 Exia version -40...175°F
 Exd version -40...167°F
Medium temperature range -40...248°F

over 248°F – measurement with use an impulse line or diaphragm seals
 up to 212°F – PED version

CAUTION: the medium must not be allowed to freeze in the impulse line or close to the process connection of the transmitter

Accuracy depending on the set range

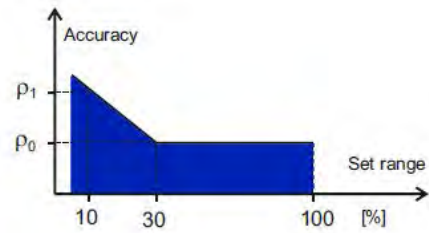

ρ_0 – error for range 30...100% FSO

ρ_1 – error for range 10% FSO

$\rho_1 = 2 \times \rho_0$

Numerical error values are given in the technical data under metrological parameters

SMART PRESSURE TRANSMITTER APC-2000ALW version with MID

Application

Smart pressure transmitter APC-2000ALW MID is applicable to the measurement of the pressure and absolute pressure in application designed according to directive 2004/22/EC (MID), harmonized standard PN-EN12405-1:2005 + A2:2010 and recommendation OIML R140:2007. Device subcomponent suitable for custody transfer measurement of gas with MID approval. Mechanical construction and installation of the transmitter enclosure shall comply with the transmitter APC-2000ALW are described on page I/ 3 of catalogue. Pressure transmitters APC-2000ALW MID are produced only with nominal ranges according to the table. Transmitter due to factory blockade of transmitter's configuration cannot be configurable by user. Electrical connection of the transmitter is according to drawing on page I/ 3. Available are only terminals SIGNAL + and SIGNAL -. Note! For custody transfer applications, the cover clamp screws have to be locked with seal wire.

Metrological parameters

Max. permissible error according to EN12405-1 (calculated in relation to the measured value)

- in reference conditions $\leq 0.2\%$
 - nominal operating conditions $\leq 0.5\%$
 special version $\leq 0.3\%$

Long-term stability $< 0.5\% / 5$ years

Operating temperature range -13...131°F

Power supply Exia: 13,5...28 VDC
 Exd: 13,5...45 VDC

MID Parts Certificate No. 27/12

Measuring ranges

Nominal measuring range	Overpressure limit (without hysteresis)
145+1,450 psia	6525 psi
30+300 psia	725 psi
30+300 psi	725 psi
13+100 psia	200 psi
13+100 psi	200 psi

Ordering procedure

Model	Code	Description
APC-2000		Smart pressure transmitter
Casing, output signal	/ALW.....	Aluminum housing, IP66/IP67, with display, output 4-20mA + Hart
	/MID.....	MID – certificate acc. to 2004/22/EC directive and OIML R140:2007 recommendations
Versions, certificates	/Exia..... /Exd.....	II 1/2G Ex ia IIC T4/T5 Ga/Gb, II 1 D Ex ia IIIC T105°C Da II 1/2G Ex ia/db IIC T5/T6 Ga/Gb, II 1/2D Ex ia/tb IIIC T85°C /T100°C Da/Db
Nominal measuring range	/145+1450 psia /30+300 psia /30+300 psi /13+ 100 psia /13+ 100 psi	145+1450 psia with possibility of changing, min. range 145+1000 psia 30+300 psia 30+300 psi 13+100 psia 13+100 psi
Process connections	/M..... /G1/2..... /G1/2(Au)..... /P..... /GP..... /1/2"NPTM..... /1/2"NPTF.....	Thread M20x1,5 (male) with R4 hole, wetted parts SS316L Thread G1/2" (male) with R4 hole, wetted parts SS316L Thread G1/2" (male) with R4 hole, gold plated diaphragm Thread M20x1,5 (male) with R12 hole, wetted parts SS316L Thread G1/2" (male) with R12 hole, wetted parts SS316L Thread 1/2"NPT Male, wetted parts SS316L Thread M20x1,5 with adapter to 1/2"NPT Female, wetted parts SS316L
Electrical connection	(without marking) /US.....	Packing gland M20x1,5 Thread 1/2"NPT Female
Accessories	/AL..... /AL(SS)..... /ST..... /MT.....	Mounting bracket type AL for 2" pipe, material zinc steel Mounting bracket type AL for 2" pipe, material stainless steel Stainless Steel plate riveted to the housing Stainless Steel Tag plate mounted on wire

Ordering procedure

Model	Code	Description																																																
APC-2000		Smart pressure transmitter																																																
Casing, output signal	/ALW.....	Aluminum housing, IP66, with display, output 4-20mA + Hart																																																
	/ALW/SS.....	Stainless steel housing, IP66, with display, output 4-20mA + Hart																																																
Versions, certificates*	/Exia.....	<div style="display: flex; justify-content: space-between;"> <div style="width: 60%;"> <p>Ex II 1/2G Ex ia IIC T4/T5 Ga/Gb Ex ia IIC T4/T5 Ga/Gb</p> <p>IECEX Ex ia IIC T4/T5 Ga/Gb</p> </div> <div style="width: 35%; text-align: center;"> <p>Packing gland available on request</p> </div> </div>																																																
	/Exia (Da).....	<div style="display: flex; justify-content: space-between;"> <div style="width: 60%;"> <p>Ex II 1/2G Ex ia IIC T4/T5 Ga/Gb II 1D Ex ia IIIC T105°C Da I M1 Ex ia I Ma (version with SS housing) Ex ia IIC T4/T5 Ga/Gb IECEX Ex ia IIIC T105°C Da Ex ia I Ma (version with SS housing)</p> </div> <div style="width: 35%; text-align: center;"> <p>Packing gland available on request</p> </div> </div>																																																
	/Exd.....	<div style="display: flex; justify-content: space-between;"> <div style="width: 60%;"> <p>Ex II 1/2G Ex ia/db IIC T6/T5 Ga/Gb II 1/2D Ex ia/tb IIIC T85°C/T100°C Da/Db I M2 Exd ia I Mb (version with SS housing) Ex ia/db IIC T6/T5 Ga/Gb IECEX Ex ia/tb IIIC T85°C/T100°C Da/Db Ex db ia I Mb (version with SS housing)</p> </div> <div style="width: 35%; text-align: center;"> <p>Packing gland available on request</p> </div> </div> <p>not available for ranges no. 16+19</p>																																																
	/Exd (2G).....	<div style="display: flex; justify-content: space-between;"> <div style="width: 60%;"> <p>Ex II 2G Ex ia/db IIC T6/T5 Gb II 2D Ex ia/tb IIIC T185°F/T212°F Db IECEX Ex ia/db IIC T6/T5 Gb Ex ia/tb IIIC T185°F/T212°F Db</p> </div> <div style="width: 35%; text-align: center;"> <p>Packing gland available on request</p> </div> </div>																																																
	/SA.....	Surge arrester for Exia version																																																
	/Safety.....	SIL2 - Functional Safety certificate according to PN-EN 61508-1:2010; PN-EN 61508-2:2010; PN-EN 61508-3:2010; PN-EN 61511-1:2007; PN-EN 62061:2008+A1 not available for ranges no. 16+19																																																
	/PED.....	European Pressure Equipment Directive N° 97/23/EC, category IV not available for transmitters with Hastelloy C 276 wetted parts																																																
	/HS.....	Ultra stable version (only ranges no. 3+19, process connections: P, GP and "NPTM)																																																
	/0,05%.....	Accuracy \pm 0.05%																																																
	/0,04%.....	Accuracy \pm 0.04%																																																
	/MR.....	Marine certificate – DNV, BV																																																
	/Tlen.....	For oxygen service (sensor filled with Fluorolube fluid), only G1/2" connection																																																
	/-40...80°C.....	Extended thermal compensation range -40 + 175°F																																																
/IP67.....	Protection class IP67																																																	
/NACE.....	NACE MR-01-75 certificate (process connections: M, G1/2", P, GP and "NPTM)																																																	
Nominal measuring range	/0+14,500 psi.....	<table border="1" style="width: 100%; border-collapse: collapse;"> <thead> <tr> <th style="width: 33%;">Range</th> <th style="width: 33%;">Min. set range</th> </tr> </thead> <tbody> <tr><td>0+14,500 psi</td><td>145 psi</td></tr> <tr><td>0+8,700 psi</td><td>87 psi</td></tr> <tr><td>0+4,350 psi</td><td>45 psi</td></tr> <tr><td>0+2,320 psi</td><td>23 psi</td></tr> <tr><td>0+1,000 psi</td><td>10 psi</td></tr> <tr><td>-15+1,000 psi</td><td>3.6 psi</td></tr> <tr><td>0+360 psi</td><td>3.6 psi</td></tr> <tr><td>-15+360 psi</td><td>1 psi</td></tr> <tr><td>0+100 psi</td><td>1 psi</td></tr> <tr><td>-15+100 psi</td><td>1.70 psi</td></tr> <tr><td>-15+21.75 psi</td><td>0.30 psi</td></tr> <tr><td>0+30 psi</td><td>1.50 psi</td></tr> <tr><td>0+15 psi</td><td>0.75 psi</td></tr> <tr><td>-7.25-7.25 psi</td><td>0.35 psi</td></tr> <tr><td>0+3.5 psi</td><td>0.30 psi</td></tr> <tr><td>-1.5-1.5 psi</td><td>0.07 psi</td></tr> <tr><td>-0.25-1 psi</td><td>0.03 psi</td></tr> <tr><td>-0.35-0.35 psi</td><td>0.015 psi</td></tr> <tr><td>-0.1-0.1 psi</td><td>1.50 psia</td></tr> <tr><td>0+20 psia</td><td>1.50 psia</td></tr> <tr><td>0+100 psia</td><td>3.6 psia</td></tr> <tr><td>0+360 psia</td><td>10 psia</td></tr> <tr><td>0+1,000 psia</td><td>45 psia</td></tr> </tbody> </table>	Range	Min. set range	0+14,500 psi	145 psi	0+8,700 psi	87 psi	0+4,350 psi	45 psi	0+2,320 psi	23 psi	0+1,000 psi	10 psi	-15+1,000 psi	3.6 psi	0+360 psi	3.6 psi	-15+360 psi	1 psi	0+100 psi	1 psi	-15+100 psi	1.70 psi	-15+21.75 psi	0.30 psi	0+30 psi	1.50 psi	0+15 psi	0.75 psi	-7.25-7.25 psi	0.35 psi	0+3.5 psi	0.30 psi	-1.5-1.5 psi	0.07 psi	-0.25-1 psi	0.03 psi	-0.35-0.35 psi	0.015 psi	-0.1-0.1 psi	1.50 psia	0+20 psia	1.50 psia	0+100 psia	3.6 psia	0+360 psia	10 psia	0+1,000 psia	45 psia
	Range	Min. set range																																																
	0+14,500 psi	145 psi																																																
	0+8,700 psi	87 psi																																																
	0+4,350 psi	45 psi																																																
	0+2,320 psi	23 psi																																																
	0+1,000 psi	10 psi																																																
	-15+1,000 psi	3.6 psi																																																
	0+360 psi	3.6 psi																																																
	-15+360 psi	1 psi																																																
	0+100 psi	1 psi																																																
	-15+100 psi	1.70 psi																																																
	-15+21.75 psi	0.30 psi																																																
	0+30 psi	1.50 psi																																																
	0+15 psi	0.75 psi																																																
	-7.25-7.25 psi	0.35 psi																																																
	0+3.5 psi	0.30 psi																																																
-1.5-1.5 psi	0.07 psi																																																	
-0.25-1 psi	0.03 psi																																																	
-0.35-0.35 psi	0.015 psi																																																	
-0.1-0.1 psi	1.50 psia																																																	
0+20 psia	1.50 psia																																																	
0+100 psia	3.6 psia																																																	
0+360 psia	10 psia																																																	
0+1,000 psia	45 psia																																																	
/0+8,700 psi.....																																																		
/0+4,350 psi.....																																																		
/0+2,320 psi.....																																																		
/0+1,000 psi.....																																																		
-15+1,000 psi.....																																																		
0+360 psi.....																																																		
-15+360 psi.....																																																		
0+100 psi.....																																																		
-15+100 psi.....																																																		
-15+21.75 psi.....																																																		
0+30 psi.....																																																		
0+15 psi.....																																																		
-7.25-7.25 psi.....																																																		
0+3.5 psi.....																																																		
-1.5-1.5 psi.....																																																		
-0.25-1 psi.....																																																		
-0.35-0.35 psi.....																																																		
-0.1-0.1 psi.....																																																		
0+20 psia.....																																																		
0+100 psia.....																																																		
0+360 psia.....																																																		
0+1,000 psia.....																																																		
0+4,350 psia.....																																																		
Measuring set range	/...+... [required units]	Calibrated range in relation to 4mA and 20mA output																																																

See next page

Code		Description
Process connections	/M.....	Thread M20x1,5 (male) with R4 hole, wetted parts SS316L
	/G1/2.....	Thread G1/2" (male) with R4 hole, wetted parts SS316L
	/G1/2(Au).....	Thread G1/2" (male) with R4 hole, gold plated diaphragm (range no. 1, 2, 3, 4, 5)
	/P.....	Thread M20x1,5 (male) with R12 hole, wetted parts SS316L
	/GP.....	Thread G1/2" (male) with R12 hole, wetted parts SS316L
	/GP(Hastelloy).....	Thread G1/2" (male) with R12 hole, wetted parts Hastelloy C 276
	/CM30x2.....	Thread M30x2 with flush diaphragm, wetted parts SS316L (Pressure: min. 0,1bar / max. 70bar)
	/CM30x2(Hastelloy).....	Thread M30x2 with flush diaphragm, wetted parts Hastelloy C 276 (Pressure limits: min. 0,1bar / max. 70bar)
	/CG1".....	Thread G1" with flush diaphragm, wetted parts SS316L (Pressure limits: min. 0,1bar / max. 70bar)
	/CG1"(Hastelloy).....	Thread G1" with flush diaphragm, wetted parts Hastelloy C 276 (Pressure limits: min. 0,1bar / max. 70bar)
	/CG1/2".....	Thread G1/2" with flush diaphragm, wetted parts SS316L (Pressure limits: min. 2,5bar)
/1/2"NPTM.....	Thread 1/2"NPT Male, G1/4" Female, wetted parts SS316L (Pressure limits: "NPT Male max. 690bar, G1/4" Female max. 1000bar)	
/1/2"NPTF.....	Thread M20x1,5 with adapter to 1/2"NPT Female, wetted parts SS316L (Pressure limits: max. 690bar)	
/code of diaphragm seal.....	Diaphragm seal (see chapter of diaphragm seals)	
Electrical connection	(without marking) /US.....	Packing gland M20x1,5 Thread 1/2"NPT Female
Accessories	/AL.....	Mounting bracket type AL for 2" pipe, material zinced steel
	/AL(SS).....	Mounting bracket type AL for 2" pipe, material stainless steel
	/ST.....	Stainless Steel plate fixed to the housing
	/MT.....	Stainless Steel Tag plate mounted on wire

Example: Pressure transmitter, output 4...20mA + HART, version Exia, nominal measuring range 0...100 psi, calibrated range 0...85 psi, process connection "NPT male, electrical connection "NPTF.

APC-2000ALW/Exia/0..100bar/0..85psi/PD/1/2"NPTM/US